



OUR DESIGN

Long term trade...

**ENDÜSTRİYEL SOĞUTMA SİSTEMLERİ**  
INDUSTRIAL COOLING SYSTEMS



Dikey Tip Soğutucu Reyonu  
*Vertical Type Cooler Cabinet*





# BONATITAN

Dikey Tip Soğutucu Reyonu  
Vertical Type Cooler Cabinet

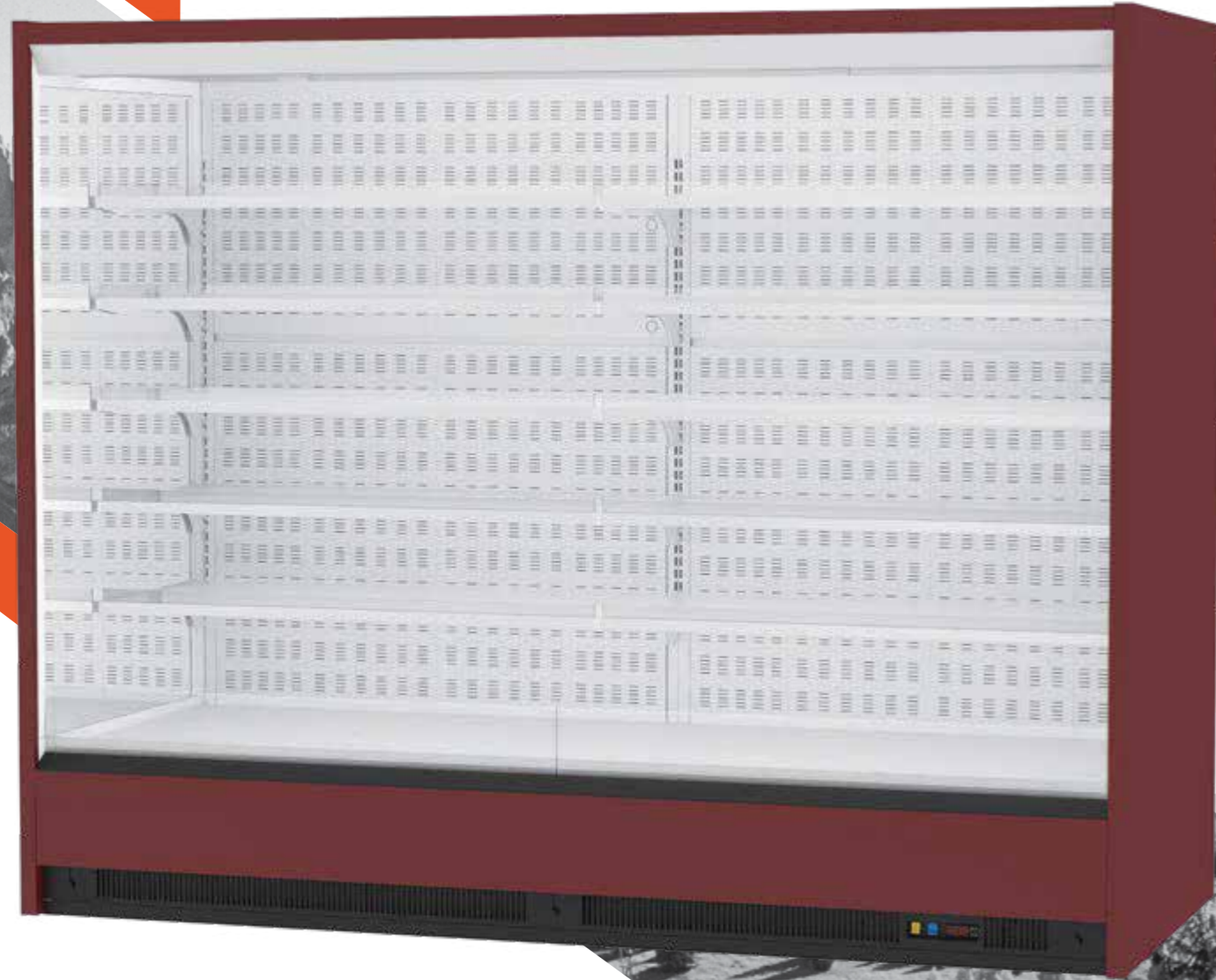

Dikey Tip Soğutucu Reyonu  
Vertical Type Cooler Cabinet

# BONATITAN

OUR DESIGN

## TEKNİK DETAYLAR

Technical Details

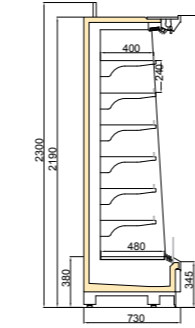

BONATITAN DP 750/H2200

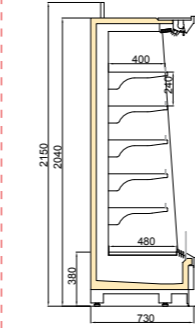

BONATITAN DP 750/H2050

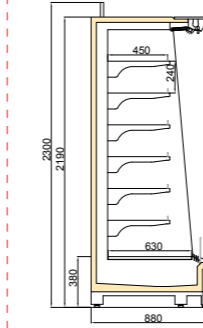

BONATITAN DP 900/H2200

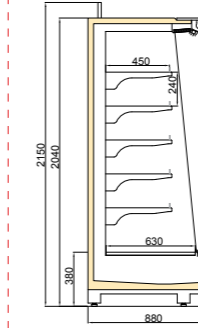

BONATITAN DP 900/H2050

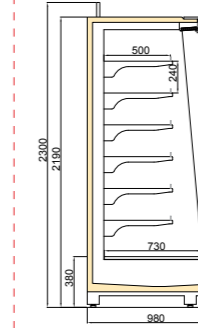

BONATITAN DP 1000/H2200

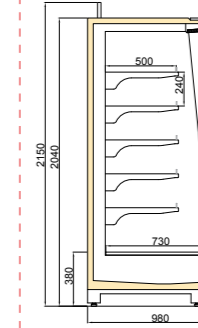

BONATITAN DP 1000/H2050

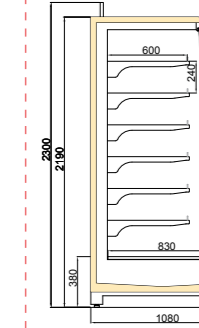

BONATITAN DP 1100/H2200

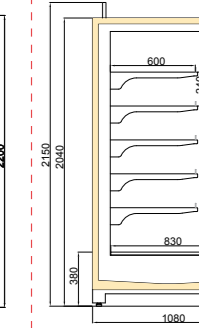

BONATITAN DP 1100/H2050

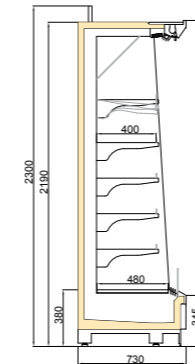

BONATITAN MT/FV 750/H2200

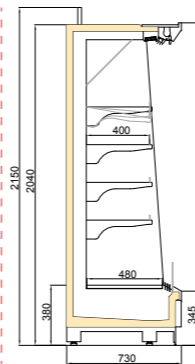

BONATITAN MT/FV 750/H2050

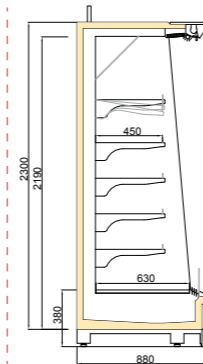

BONATITAN MT/FV 900/H2200

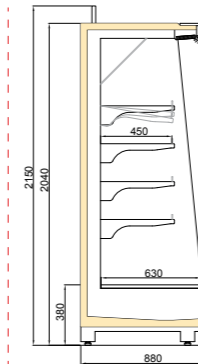

BONATITAN MT/FV 900/H2050

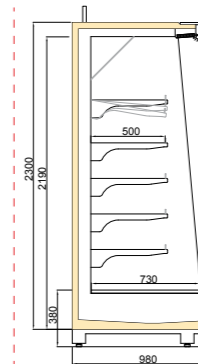

BONATITAN MT/FV 1000/H2200

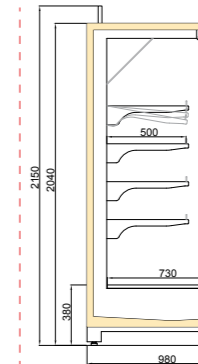

BONATITAN MT/FV 1000/H2050

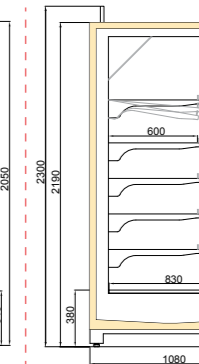

BONATITAN MT/FV 1100/H2200

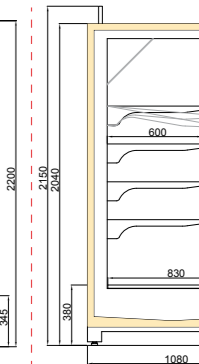

BONATITAN MT/FV 1100/H2050

Available Modules / Kullanılabilir Modüller					Operating Temperatures / Çalışma Sıcaklıkları			Ambient Conditions / Ortam Koşulları	
Length/Uzunluk (mm)	1250	1875	2500	3750	Gondola / Head	DP	MT	FV	25°C / 60% RH (EN ISO 23953-2)
Side panel/ Yan kapak (mm)	40	40	40	40	40	M2 (-1/+7°C)	M1 (-1/+5°C)	H1 (+1/+10°C)	





# BONATITAN DGD/T55

Dikey Tip Soğutucu Reyonu  
Vertical Type Cooler Cabinet

# BONATITAN DGD/T55

Dikey Tip Soğutucu Reyonu  
Vertical Type Cooler Cabinet

OUR DESIGN

## TEKNİK DETAYLAR

Technical Details

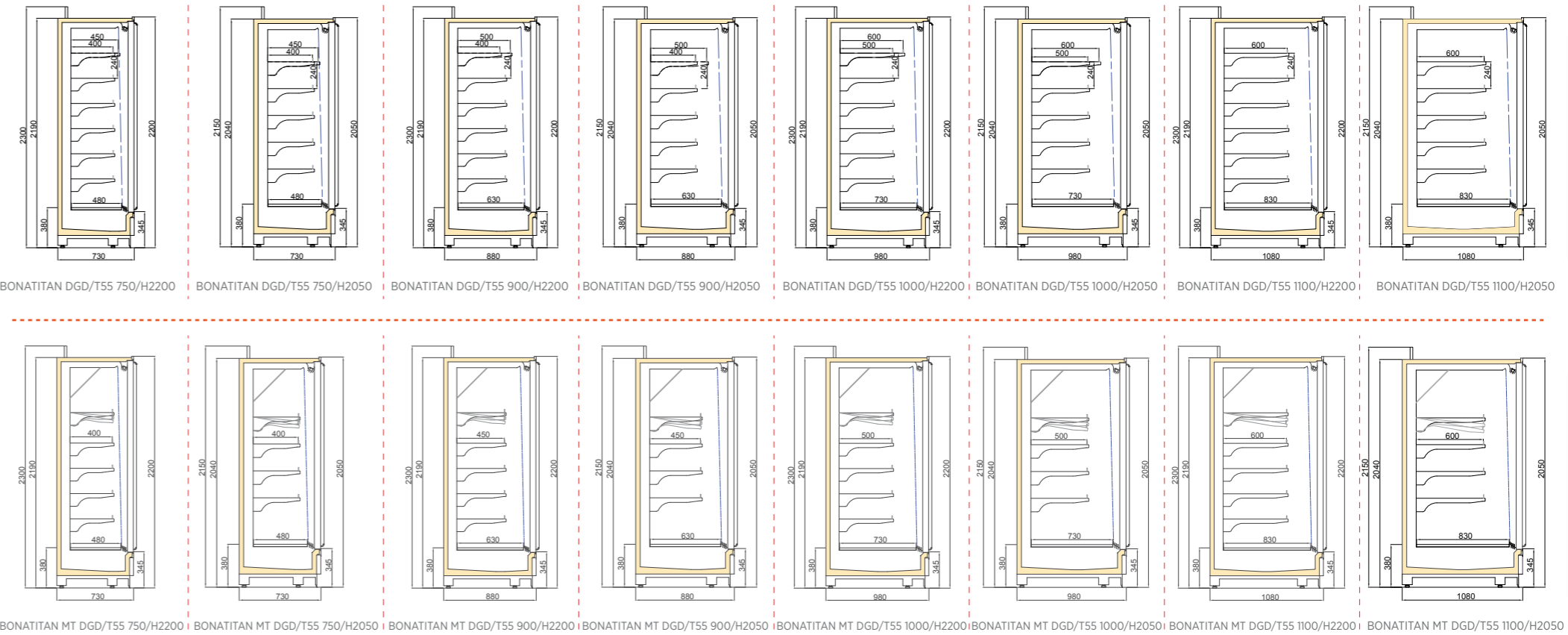

Available Modules / Kullanılabilir Modüller					Operating Temperatures / Çalışma Sıcaklıkları			Ambient Conditions / Ortam Koşulları	
Length/Uzunluk (mm)	1250	1875	2500	3750	Gondola / Head	DP	MT	FV	25°C / 60% RH (EN ISO 23953-2)
Side panel/ Yan kapak (mm)	40	40	40	40	40	M2 (-1/+7°C)	M1 (-1/+5°C)	H1 (+1/+10°C)	



SÜTLÜK / DAIRY PRODUCTS

PAKET ETİ & MEYVE VE SEBZE  
PACKED MEAT & FRUITS VEGETABLES



T55



# BONATITAN DGD/TKY

Dikey Tip Soğutucu Reyonu  
Vertical Type Cooler Cabinet



TKY

# BONATITAN DGD/TKY

Dikey Tip Soğutucu Reyonu  
Vertical Type Cooler Cabinet



## TEKNİK DETAYLAR

Technical Details

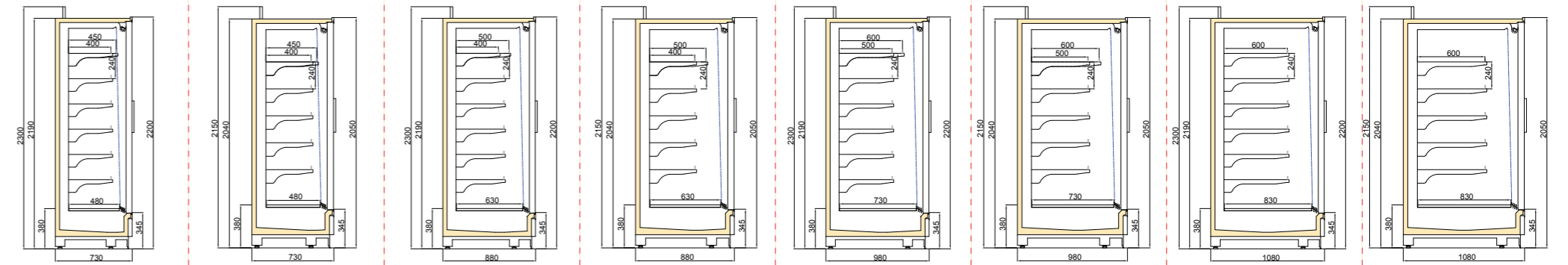

BONATITAN DGD/TKY 750/H2200 | BONATITAN DGD/TKY 750/H2050 | BONATITAN DGD/TKY 900/H2200 | BONATITAN DGD/TKY 900/H2050 | BONATITAN DGD/TKY 1000/H2200 | BONATITAN DGD/TKY 1000/H2050 | BONATITAN DGD/TKY 1100/H2200 | BONATITAN DGD/TKY 1100/H2050

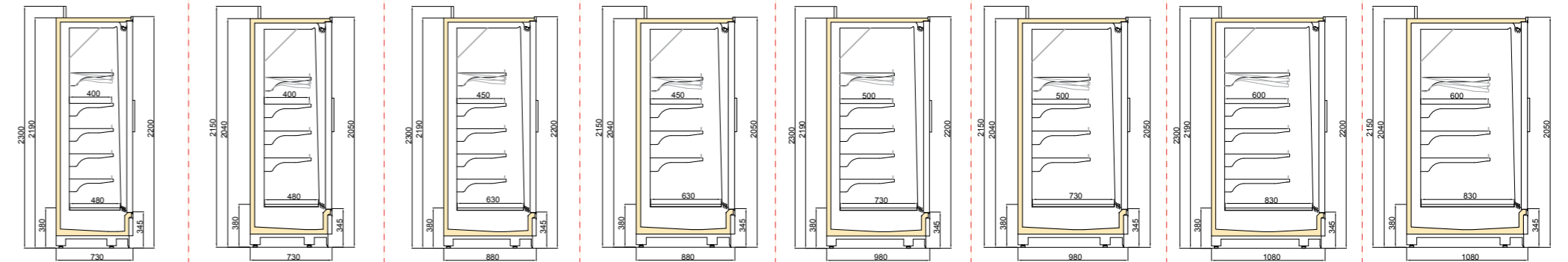

BONATITAN MT DGD/TKY 750/H2200 | BONATITAN MT DGD/TKY 750/H2050 | BONATITAN MT DGD/TKY 900/H2200 | BONATITAN MT DGD/TKY 900/H2050 | BONATITAN MT DGD/TKY 1000/H2200 | BONATITAN MT DGD/TKY 1000/H2050 | BONATITAN MT DGD/TKY 1100/H2200 | BONATITAN MT DGD/TKY 1100/H2050

Available Modules / Kullanılabilir Modüller					Operating Temperatures / Çalışma Sıcaklıkları			Ambient Conditions / Ortam Koşulları
Length/Uzunluk (mm)	1250	1875	2500	3750	Gondola / Head	DP	MT	FV
Side panel/Yan kapak (mm)	40	40	40	40	40	M2 (-1/+7°C)	M1 (-1/+5°C)	H1 (+1/+10°C)
25°C / 60% RH (EN ISO 23953-2)								



SÜTLÜK / DAIRY PRODUCTS

PAKET ETİ & MEYVE VE SEBZE  
PACKED MEAT & FRUITS VEGETABLES



# BONATITAN DGD/VNZ

Dikey Tip Soğutucu Reyonu  
Vertical Type Cooler Cabinet



VNZ

# BONATITAN DGD/VNZ

Dikey Tip Soğutucu Reyonu  
Vertical Type Cooler Cabinet



## TEKNİK DETAYLAR

Technical Details

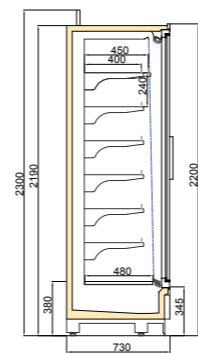

BONATITAN DGD/VNZ 750/H2200

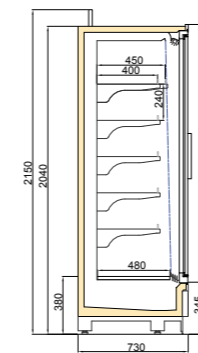

BONATITAN DGD/VNZ 750/H2050

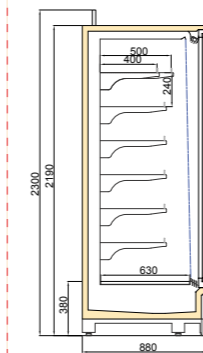

BONATITAN DGD/VNZ 900/H2200

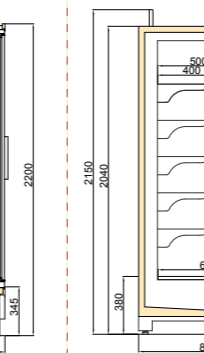

BONATITAN DGD/VNZ 900/H2050

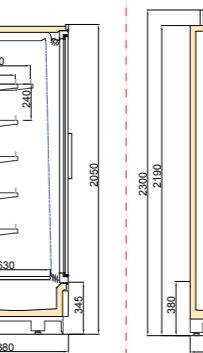

BONATITAN DGD/VNZ 1000/H2200

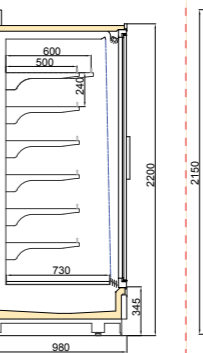

BONATITAN DGD/VNZ 1000/H2050

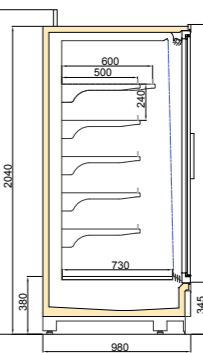

BONATITAN DGD/VNZ 1100/H2200

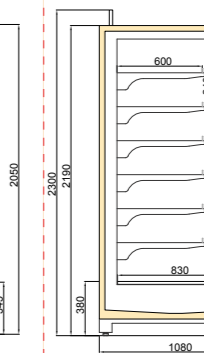

BONATITAN DGD/VNZ 1100/H2050

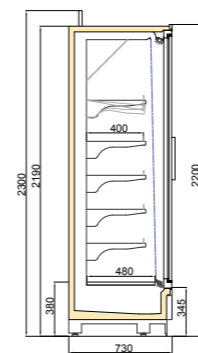

BONATITAN MT DGD/VNZ 750/H2200

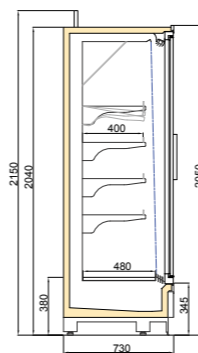

BONATITAN MT DGD/VNZ 750/H2050

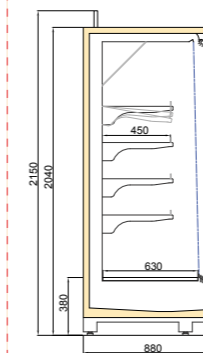

BONATITAN MT DGD/VNZ 900/H2050

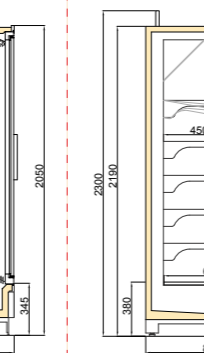

BONATITAN MT DGD/VNZ 900/H2200

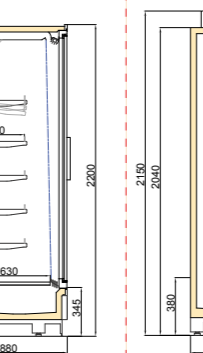

BONATITAN MT DGD/VNZ 1000/H2050

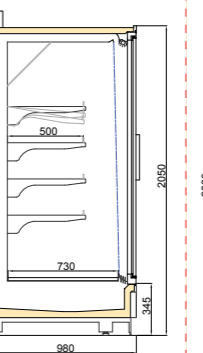

BONATITAN MT DGD/VNZ 1000/H2200

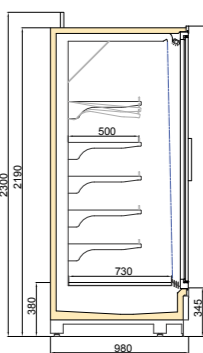

BONATITAN MT DGD/VNZ 1100/H2050

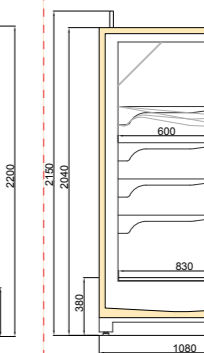

BONATITAN MT DGD/VNZ 1100/H2200

Available Modules / Kullanılabilir Modüller					Operating Temperatures / Çalışma Sıcaklıkları			Ambient Conditions / Ortam Koşulları	
Length/Uzunluk (mm)	1250	1875	2500	3750	Gondola / Head	DP	MT	FV	25°C / 60% RH (EN ISO 23953-2)
Side panel/ Yan kapak (mm)	40	40	40	40	40	M2 (-1/+7°C)	M1 (-1/+5°C)	H1 (+1/+10°C)	



SÜTLÜK / DAIRY PRODUCTS

PAKET ETİ & MEYVE VE SEBZE  
PACKED MEAT & FRUITS VEGETABLES



# BONATITAN DGD/VWL

Dikey Tip Soğutucu Reyonu  
Vertical Type Cooler Cabinet

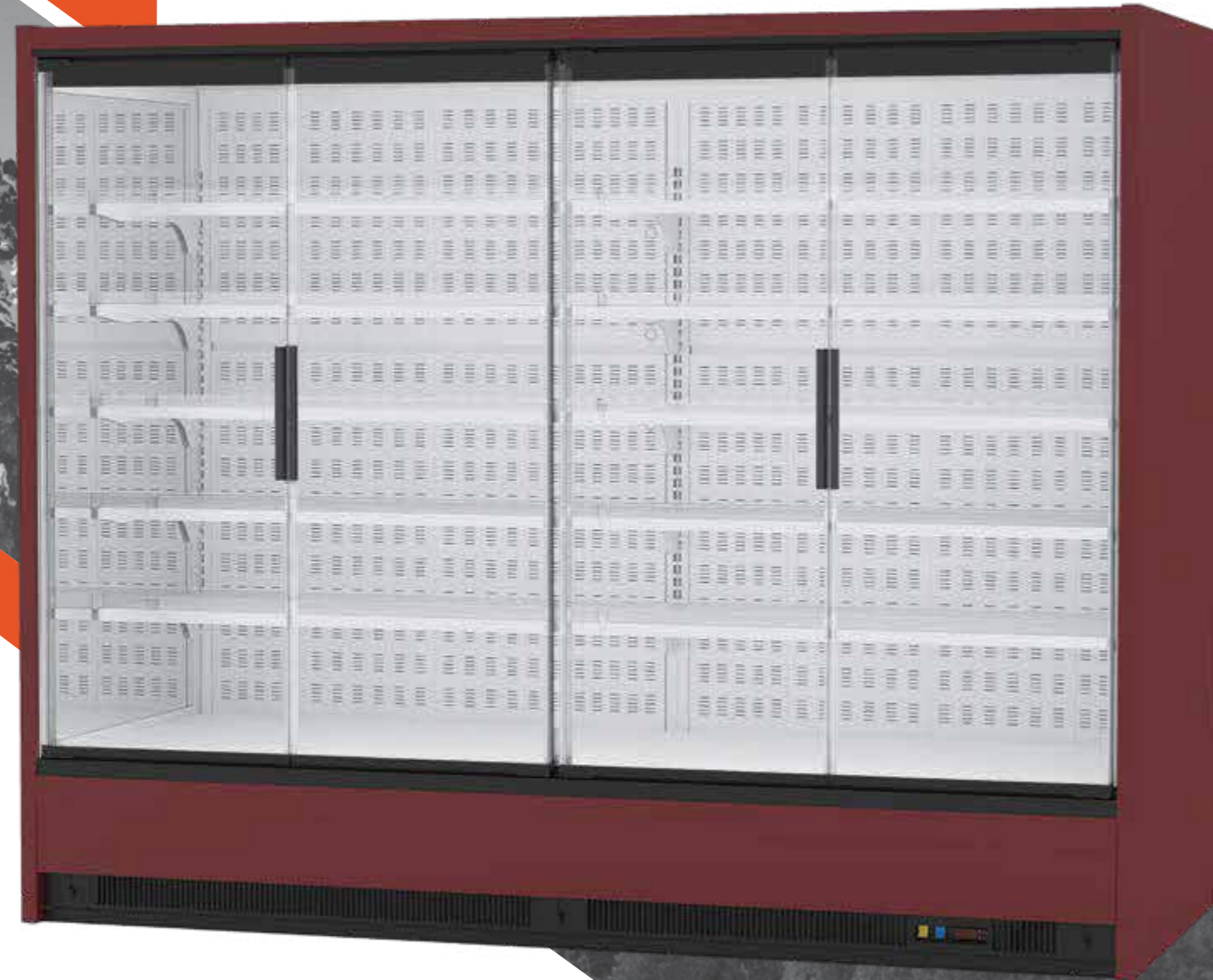

## TEKNİK DETAYLAR

Technical Details

# BONATITAN DGD/VWL

Dikey Tip Soğutucu Reyonu  
Vertical Type Cooler Cabinet

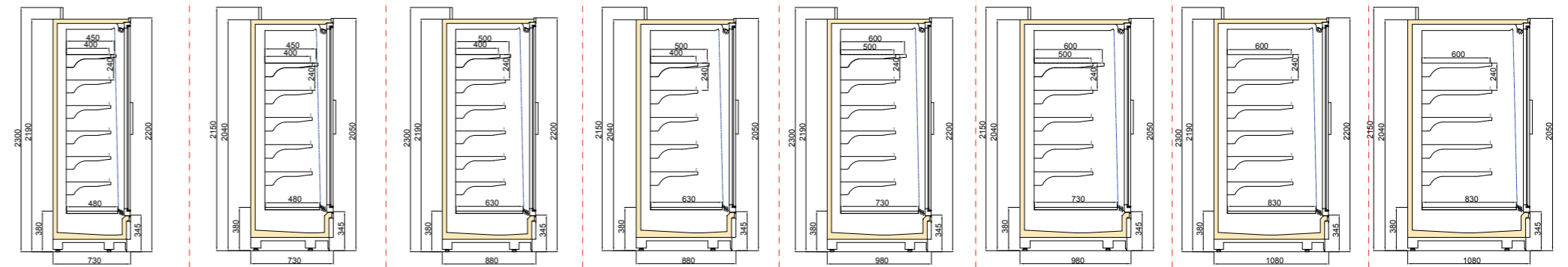

BONATITAN DGD/VWL 750/H2200 | BONATITAN DGD/VWL 750/H2050 | BONATITAN DGD/VWL 900/H2200 | BONATITAN DGD/VWL 900/H2050 | BONATITAN DGD/VWL 1000/H2200 | BONATITAN DGD/VWL 1000/H2050 | BONATITAN DGD/VWL 1100/H2200 | BONATITAN DGD/VWL 1100/H2050

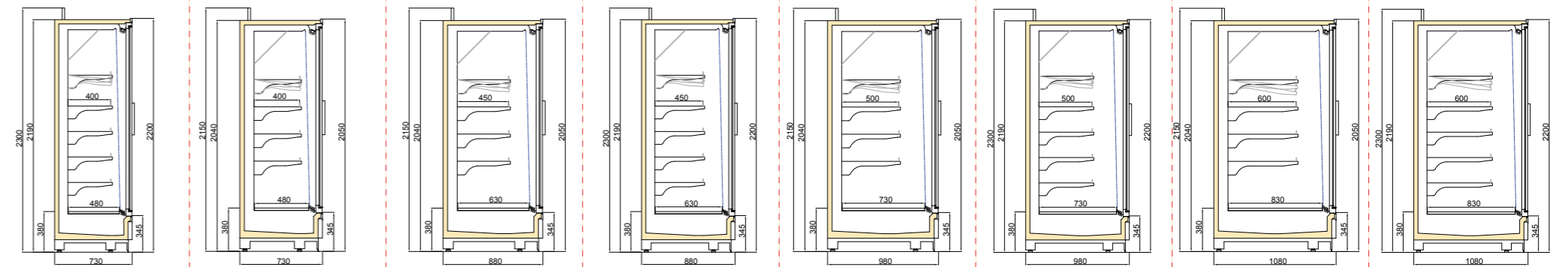

BONATITAN MT DGD/VWL 750/H2200 | BONATITAN MT DGD/VWL 750/H2050 | BONATITAN MT DGD/VWL 900/H2200 | BONATITAN MT DGD/VWL 900/H2050 | BONATITAN MT DGD/VWL 1000/H2200 | BONATITAN MT DGD/VWL 1000/H2050 | BONATITAN MT DGD/VWL 1100/H2200 | BONATITAN MT DGD/VWL 1100/H2050

Available Modules / Kullanılabilir Modüller					Operating Temperatures / Çalışma Sıcaklıkları			Ambient Conditions / Ortam Koşulları
Length/Uzunluk (mm)	1250	1875	2500	3750	Gondola / Head	DP	MT	FV
Side panel/ Yan kapak (mm)	40	40	40	40	40	M2 (-1/+7°C)	M1 (-1/+5°C)	H1 (+1/+10°C)
25°C / 60% RH (EN ISO 23953-2)								



SÜTLÜK / DAIRY PRODUCTS

PAKET ETİ & MEYVE VE SEBZE  
PACKED MEAT & FRUITS VEGETABLES



# BONATITAN P

İçten Motorlu Dikey Tip Soğutucu Reyonu  
*Plug-in Vertical Type Cooler Cabinet*

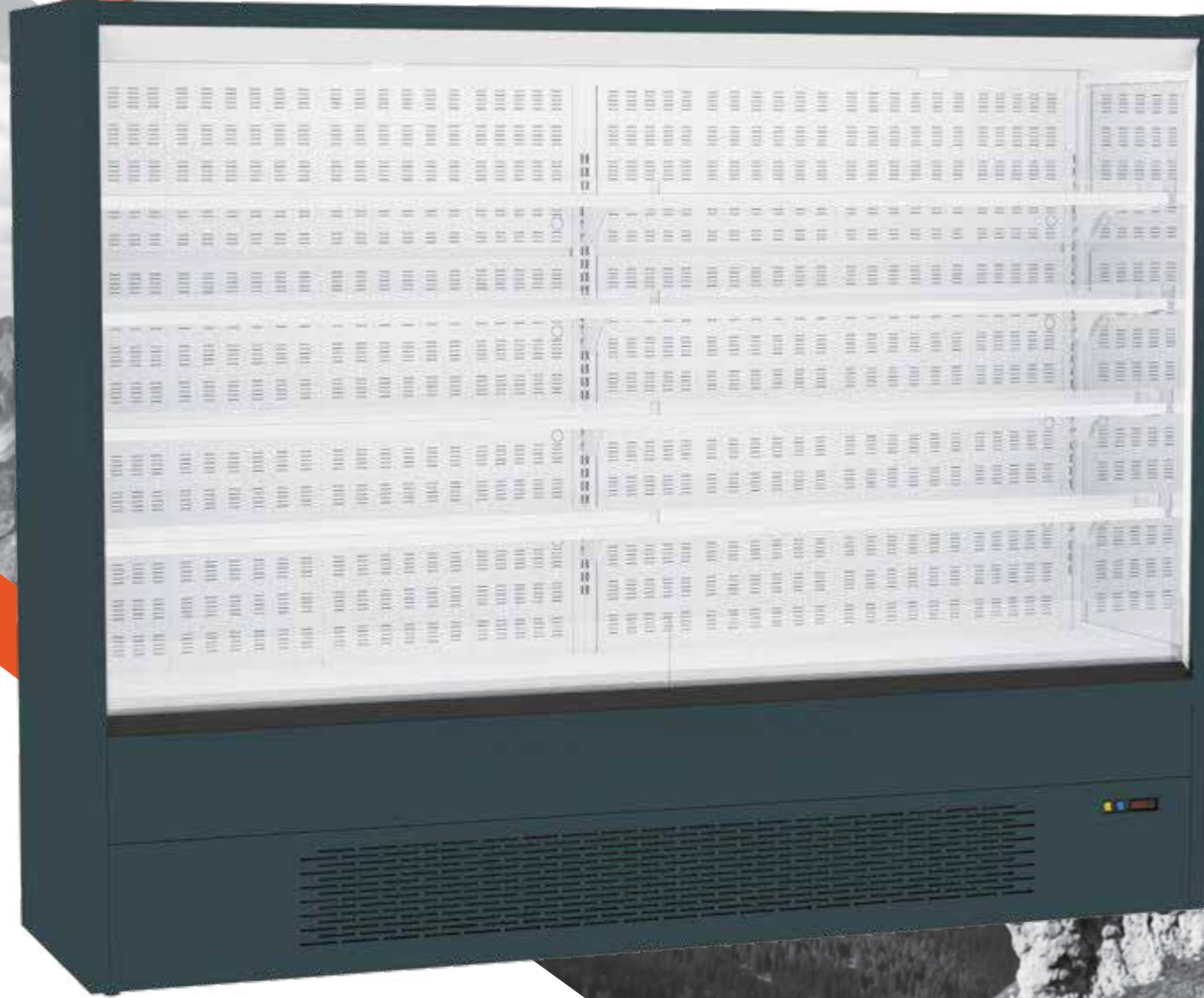

İçten Motorlu Dikey Tip Soğutucu Reyonu  
*Plug-in Vertical Type Cooler Cabinet*

# BONATITAN P DGD/T55



T55



# BONATITAN P DGD/TKY

İçten Motorlu Dikey Tip Soğutucu Reyonu  
Plug-in Vertical Type Cooler Cabinet



TKY

# BONATITAN P DGD/VNZ

İçten Motorlu Dikey Tip Soğutucu Reyonu  
Plug-in Vertical Type Cooler Cabinet

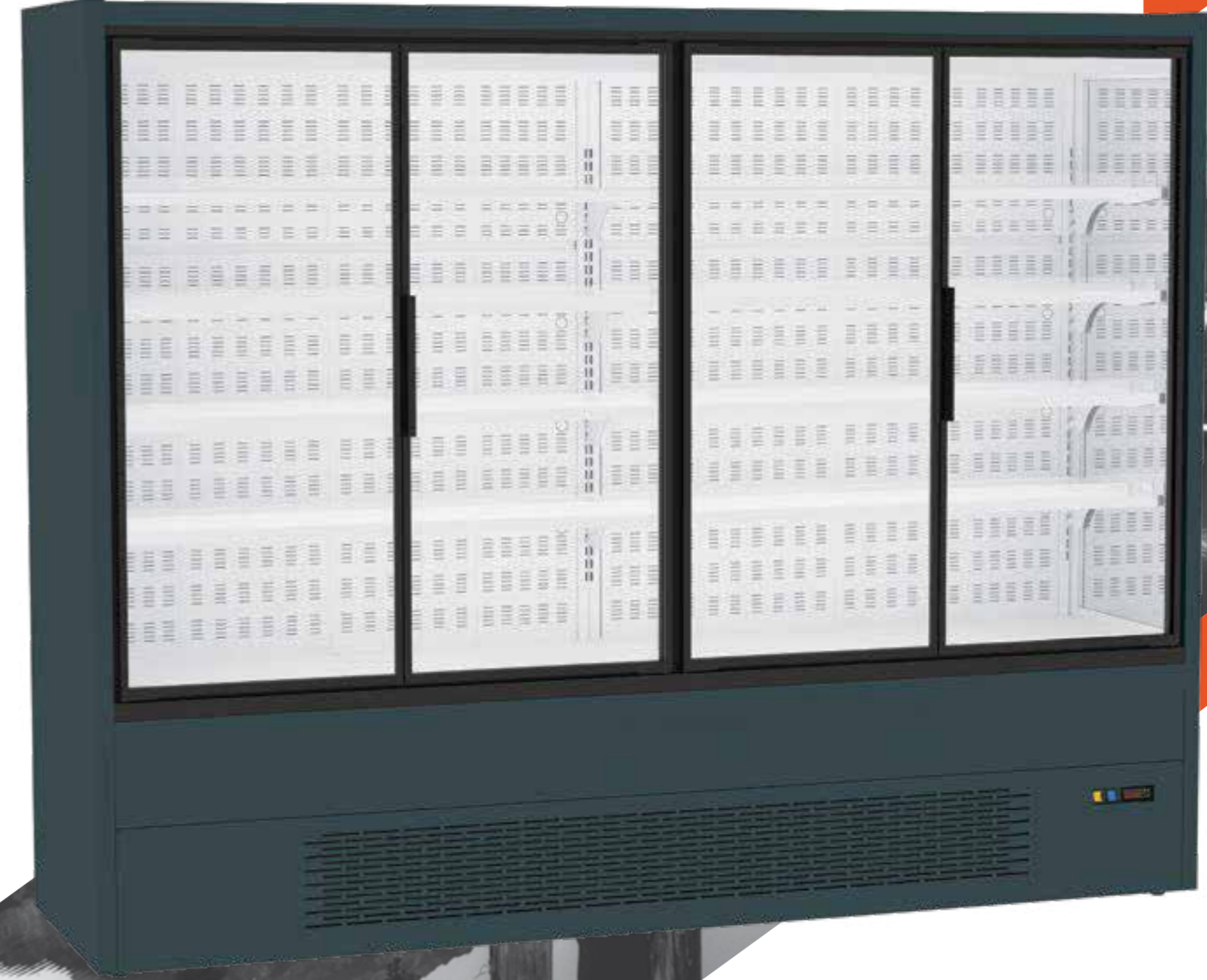

VNZ



# BONATITAN P DGD/VWL İçten Motorlu Dikey Tip Soğutucu Reyonu

Plug-in Vertical Type Cooler Cabinet

İçten Motorlu Dikey Tip Soğutucu Reyonu  
Plug-in Vertical Type Cooler Cabinet  
**BONATITAN P**

OUR DESIGN

## TEKNİK DETAYLAR

Technical Details

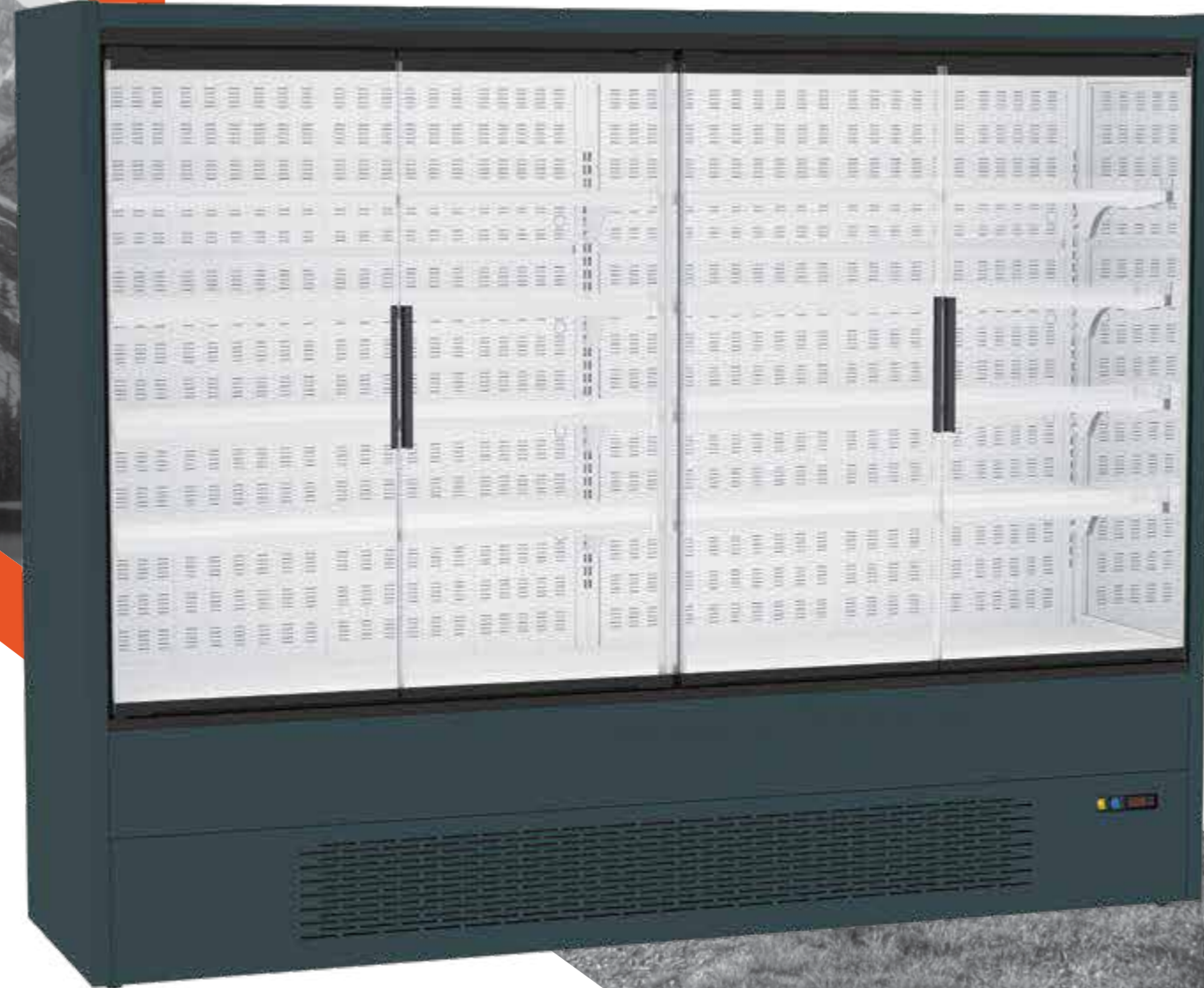

Available Modules / Kullanılabilir Modüller				
Length/Uzunluk (mm)	937	1250	1875	2500
Side panel/ Yan kapak (mm)	40	40	40	40

Operating Temperatures / Çalışma Sıcaklıkları	Ambient Conditions / Ortam Koşulları
M1 (-1/+5°C) - M2 (-1/+7°C)	25°C / 60% RH (EN ISO 23953-2)





# JOBARIA

Yarı Dikey Tip Soğutucu Reyonu  
*Semi Vertical Type Cooler Cabinet*

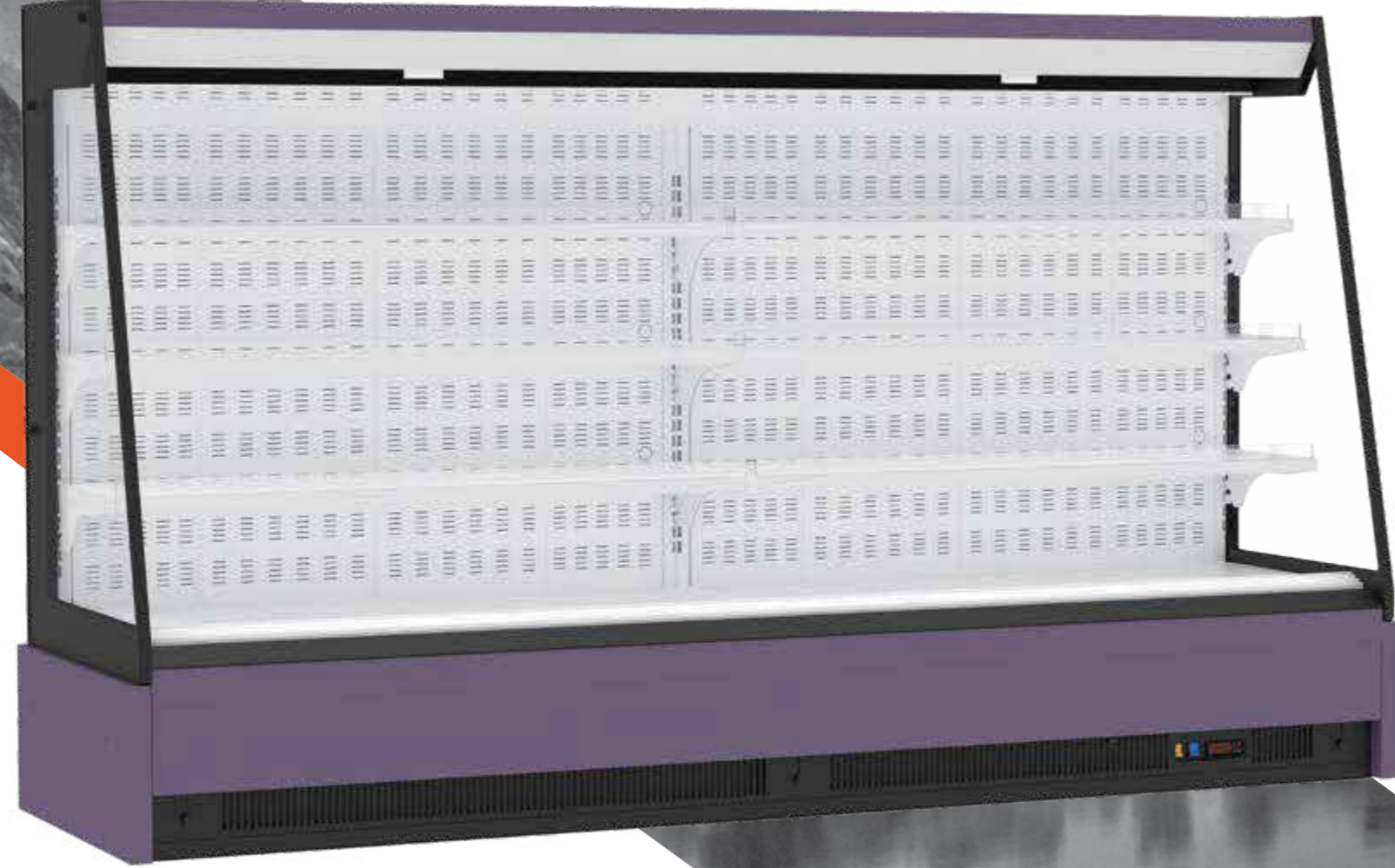

# JOBARIA/VNZ





# JOBARIA/TLD

Yarı Dikey Tip Soğutucu Reyonu  
*Semi Vertical Type Cooler Cabinet*

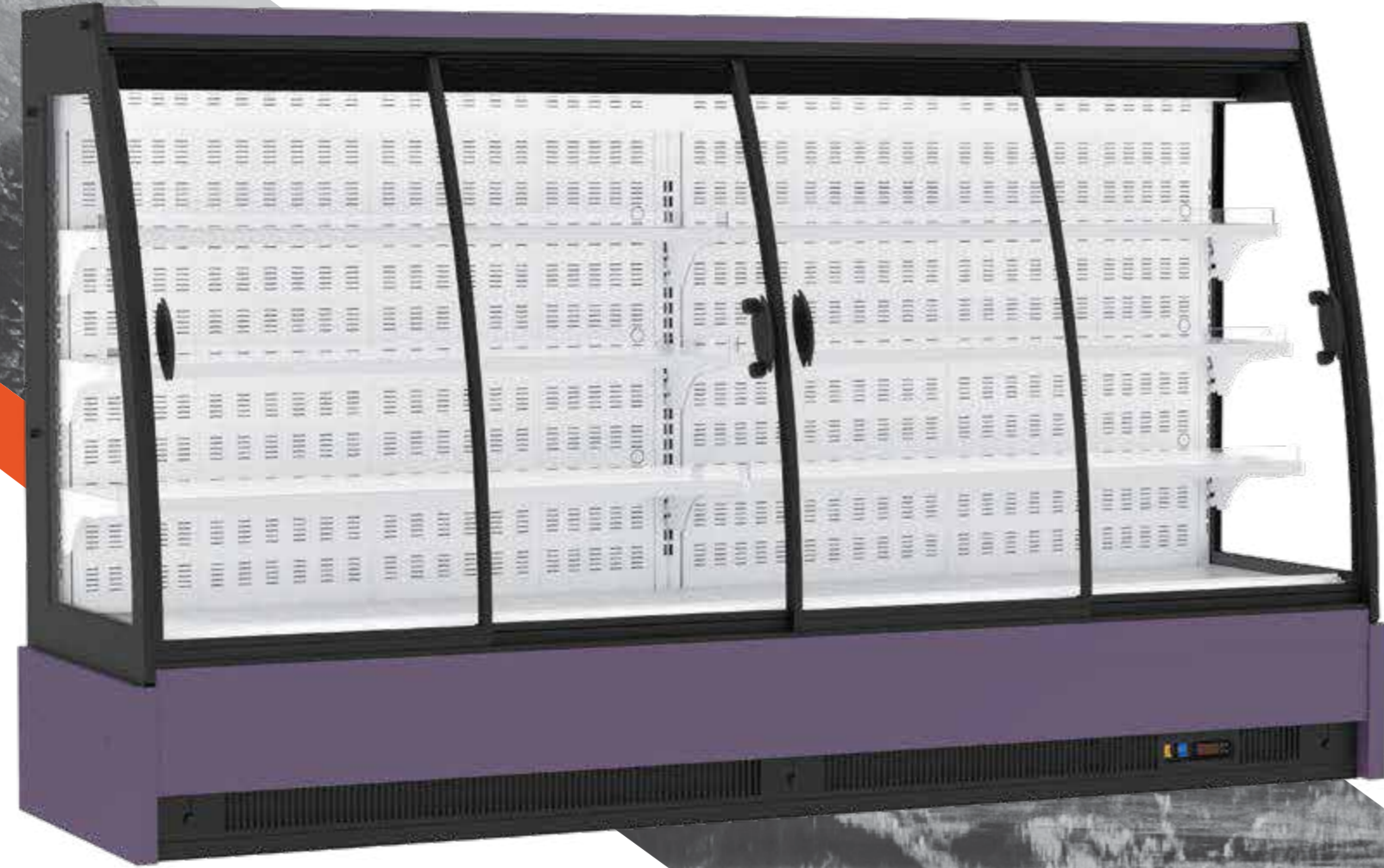

TLD

Yarı Dikey Tip Soğutucu Reyonu  
*Semi Vertical Type Cooler Cabinet*

# JOBARIA/SKY



SKY



## TEKNİK DETAYLAR Technical Details



JOBARIA DP

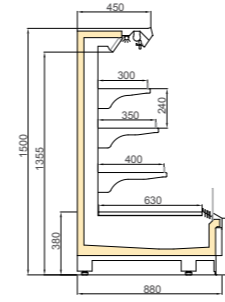

JOBARIA DP 900/HI500

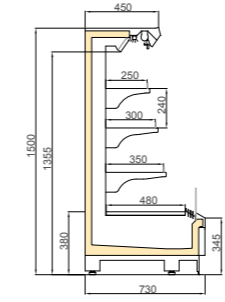

JOBARIA DP 750/HI500

JOBARIA TLD

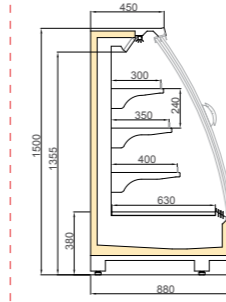

JOBARIA TLD 900/HI500

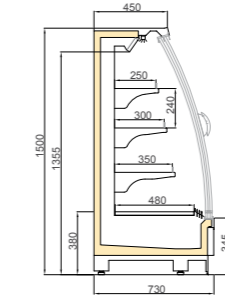

JOBARIA TLD 750/HI500

JOBARIA DGD/VNZ

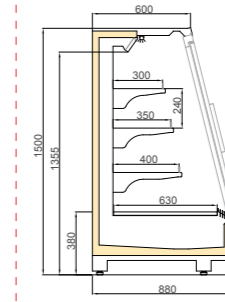

JOBARIA DGD/VNZ 900/HI500

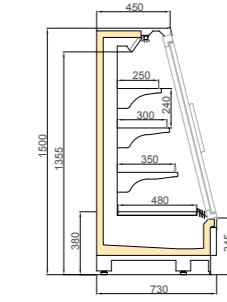

JOBARIA DGD/VNZ 750/HI500

JOBARIA DGD/SKY

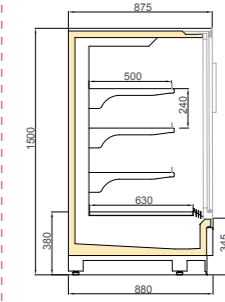

JOBARIA DGD/SKY 900/HI500

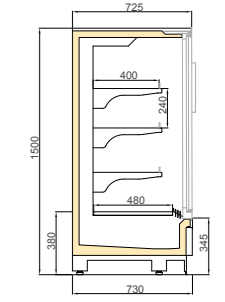

JOBARIA DGD/SKY 750/HI500

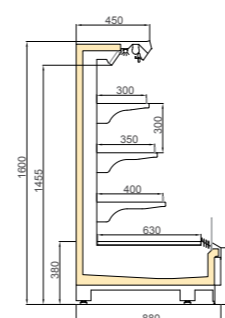

JOBARIA DP 900/HI600

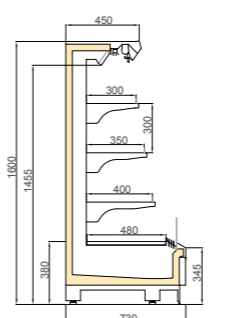

JOBARIA DP 750/HI600

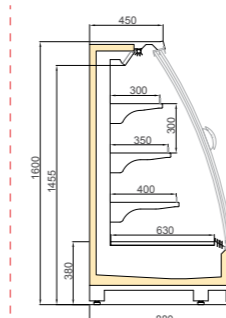

JOBARIA TLD 900/HI600

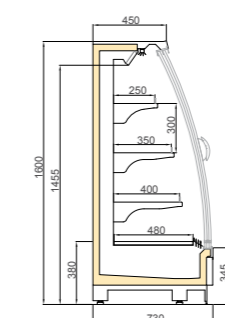

JOBARIA TLD 750/HI600

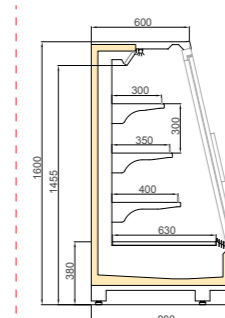

JOBARIA DGD/VNZ 900/HI600

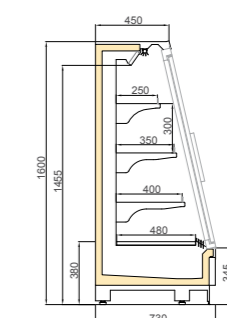

JOBARIA DGD/VNZ 750/HI600

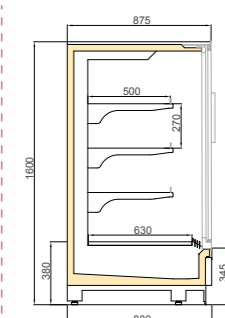

JOBARIA DGD/SKY 900/HI600

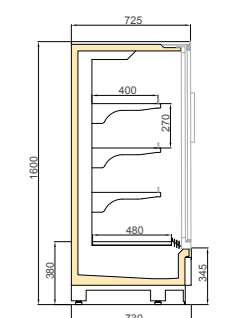

JOBARIA DGD/SKY 750/HI600

Available Modules / Kullanılabilir Modüller					Operating Temperatures / Çalışma Sıcaklıkları			Ambient Conditions / Ortam Koşulları	
Length/Uzunluk (mm)	1250	1875	2500	3750	Gondola / Head	DP	MT	FV	25°C / 60% RH (EN ISO 23953-2)
Side panel/ Yan kapak (mm)	40	40	40	40	40	M2 (-1/+7°C)	M1 (-1/+5°C)	H1 (+1/+10°C)	





Derin Dondurucu  
*Freezer*





# RAPTOREX/T80

Dikey Tip Derin Dondurucu  
Vertical Type Freezer

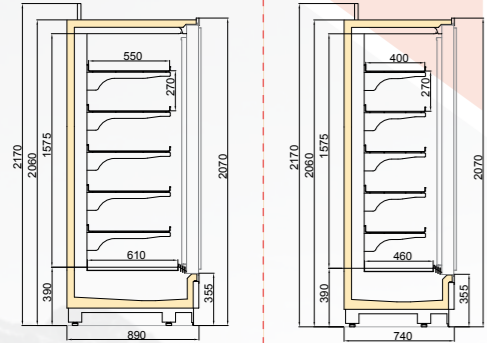

RAPTorex T80 900/H2050

RAPTorex T80 750/H2050

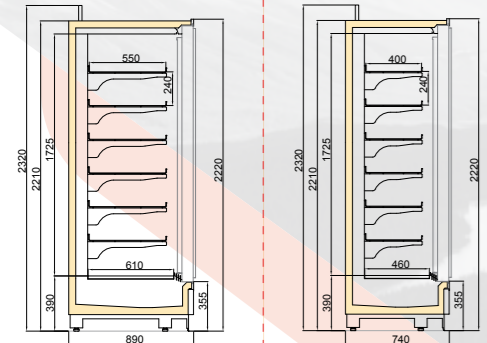

RAPTorex T80 900/H2200

RAPTorex T80 750/H2200



**T80**

Dikey Tip Derin Dondurucu  
Vertical Type Freezer

# RAPTOREX/SOFIA

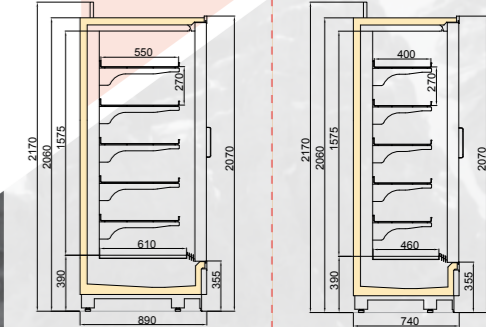

RAPTorex SOFIA 900/H2050

RAPTorex SOFIA 750/H2050

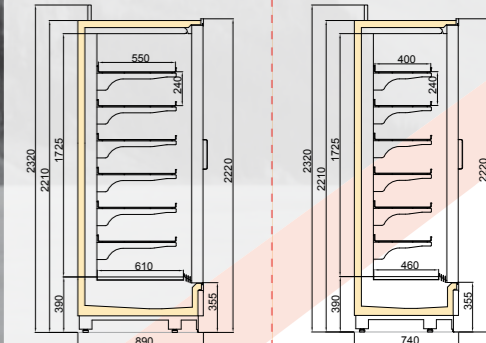

RAPTorex SOFIA 900/H2200

RAPTorex SOFIA 750/H2200



**SOFIA**

Available Modules / Kullanılabilir Modüller				
Length/Uzunluk (mm)	2D 1562	3D 2343	4D 3124	5D 3905
Side panel/ Yan kapak (mm)	50	50	50	50
Operating Temperatures / Çalışma Sıcaklıkları		Ambient Conditions / Ortam Koşulları		
L1 (-15/-18°C) - L2 (-12/-18°C)		25°C / 60% RH (EN ISO 23953-2)		





# RAPTOREX P/T80

İçten Motorlu Dikey Tip Derin Dondurucu  
Plug-in Vertical Type Freezer

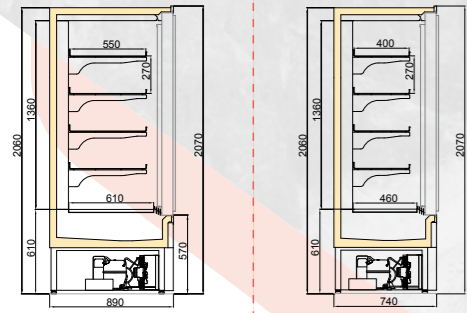

RAPTOREX P T80 900/H2050

RAPTOREX P T80 750/H2050

Available Modules / Kullanılabilir Modüller			
Length/Uzunluk (mm)	1250	1875	2500
Side panel/ Yan kapak (mm)	50	50	50

Operating Temperatures / Çalışma Sıcaklıkları	Ambient Conditions / Ortam Koşulları
L1 (-15/-18°C) - L2 (-12/-18°C)	25°C / 60% RH (EN ISO 23953-2)



**T80**



İçten Motorlu Dikey Tip Derin Dondurucu  
Plug-in Vertical Type Freezer

# RAPTOREX P/SOFIA

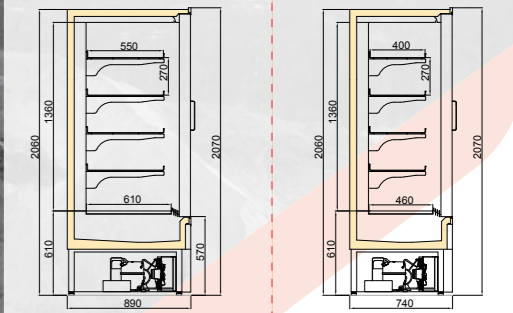

RAPTOREX P SOFIA 900/H2050

RAPTOREX P SOFIA 750/H2050

Available Modules / Kullanılabilir Modüller			
Length/Uzunluk (mm)	1250	1875	2500
Side panel/ Yan kapak (mm)	50	50	50

Operating Temperatures / Çalışma Sıcaklıkları	Ambient Conditions / Ortam Koşulları
L1 (-15/-18°C) - L2 (-12/-18°C)	25°C / 60% RH (EN ISO 23953-2)



**SOFIA**





# CITIPATI BOX

Dikey Tip Derin Dondurucu  
Vertical Type Freezer

İçten Motorlu Dikey Tip Derin Dondurucu  
Vertical Type Plug-in Freezer

# RAPTOREX P LB

OUR DESIGN

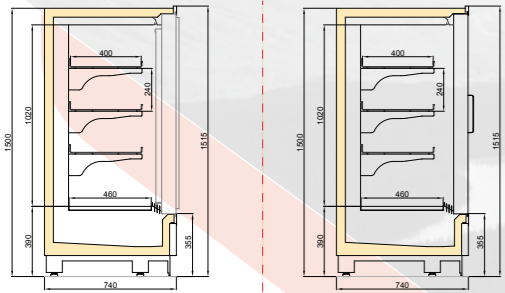

CITIPATI BOX T80 750/H1500 | CITIPATI BOX SOFIA 750/H1500

Available Modules / Kullanılabilir Modüller				
Length/Uzunluk (mm)	2D	3D	4D	5D
	1562	2343	3124	3905
Side panel/ Yan kapak (mm)	50	50	50	50
Operating Temperatures / Çalışma Sıcaklıkları		Ambient Conditions / Ortam Koşulları		
L1 (-15/-18°C) - L2 (-12/-18°C)		25°C / 60% RH (EN ISO 23953-2)		

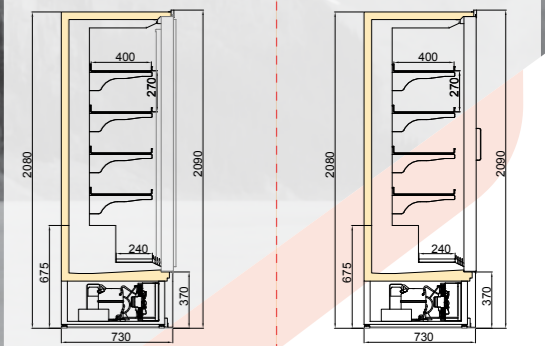

RAPTOREX P LB T80 750/H2050 | RAPTOREX P LB SOFIA 750/H2050

Available Modules / Kullanılabilir Modüller			
Length/Uzunluk (mm)	1250	1875	2500
Side panel/ Yan kapak (mm)	50	50	50
Operating Temperatures / Çalışma Sıcaklıkları		Ambient Conditions / Ortam Koşulları	
L1 (-15/-18°C) - L2 (-12/-18°C)		25°C / 60% RH (EN ISO 23953-2)	



SOFIA





Soğutmalı Servis Reyonu  
*Refrigerated Serve Over Counter*





# SPINOSAURUS

Düz Camlı Soğutmalı Servis Reyonu  
Refrigerated Serve Over Counter With Flat Glass

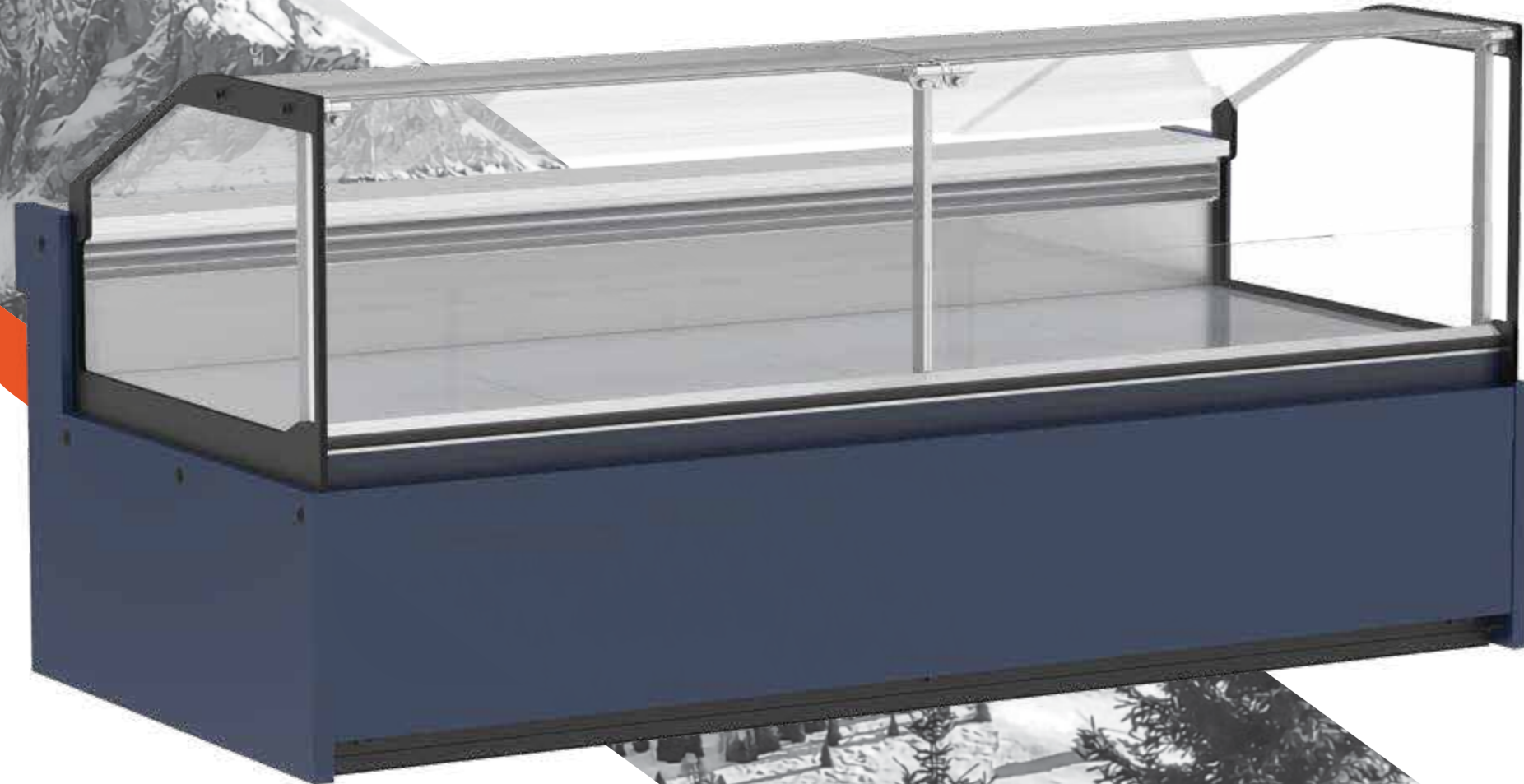

Soğutmalı Servis Reyonu  
Refrigerated Serve Over Counter  
**SPINOSAURUS**

OUR DESIGN

## TEKNİK DETAYLAR Technical Details

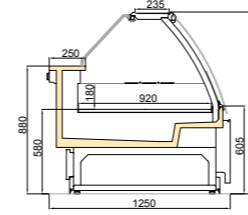

SPINOSAURUS 900 CG

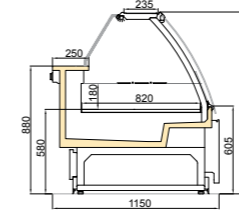

SPINOSAURUS 800 CG

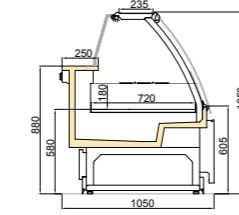

SPINOSAURUS 700 CG

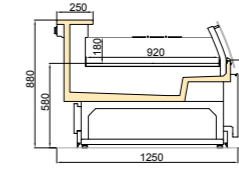

SPINOSAURUS 900 CG/SS

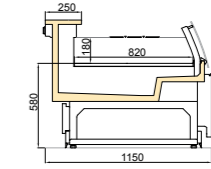

SPINOSAURUS 800 CG/SS

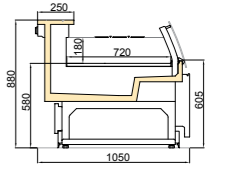

SPINOSAURUS 700 CG/SS

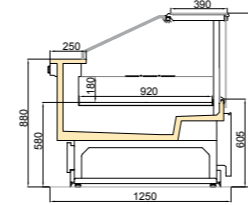

SPINOSAURUS 900 FG

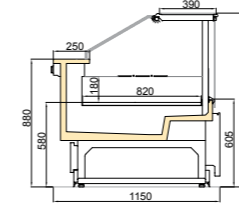

SPINOSAURUS 800 FG

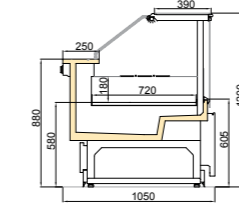

SPINOSAURUS 700 FG

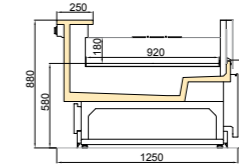

SPINOSAURUS 900 FG/SS

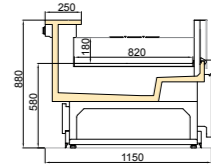

SPINOSAURUS 800 FG/SS

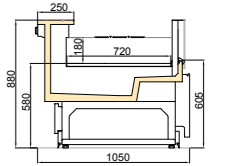

SPINOSAURUS 700 FG/SS

### Available Modules / Kullanılabilir Modüller

Length/Uzunluk (mm)	937	1250	1875	2500	3750	Gondola / Head
Side panel/ Yan kapak (mm)	40	40	40	40	40	40

### Operating Temperatures / Çalışma Sıcaklıkları

M1 (-1/+5°C) - M2 (-1/+7°C)

### Ambient Conditions / Ortam Koşulları

25°C / 60% RH (EN ISO 23953-2)





# SPINOSAURUS P

İçten Motorlu Düz Camlı Soğutmalı Servis Reyonu  
Plug-in Refrigerated Serve Over Counter With Flat Glass

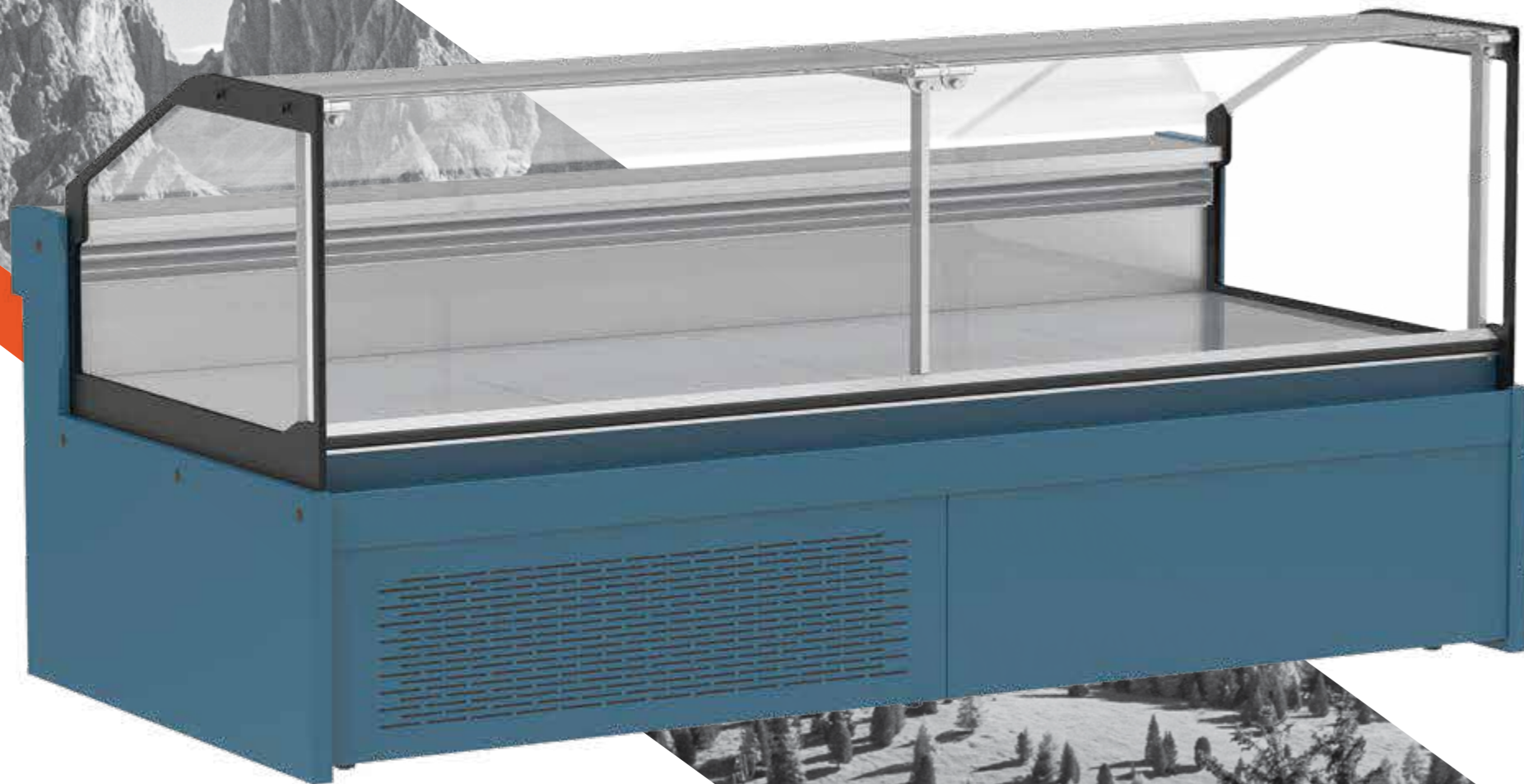

İçten Motorlu Soğutmalı Servis Reyonu  
Plug-in Refrigerated Serve Over Counter  
**SPINOSAURUS P**

OUR DESIGN

## TEKNİK DETAYLAR

Technical Details

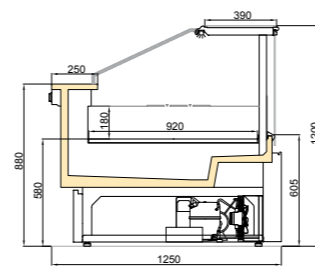

SPINOSAURUS P 900 FG

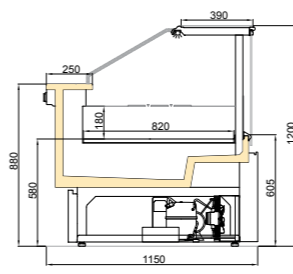

SPINOSAURUS P 800 FG

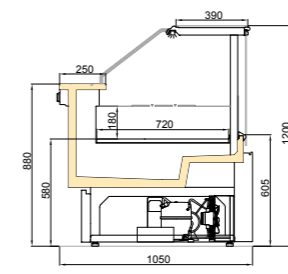

SPINOSAURUS P 700 FG

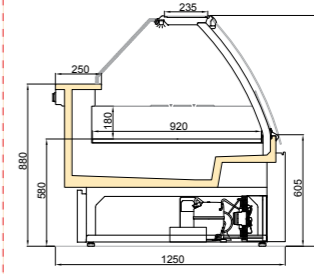

SPINOSAURUS P 900 CG

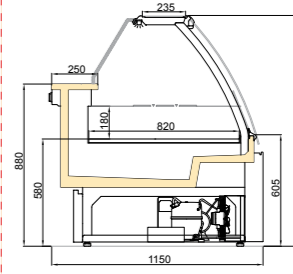

SPINOSAURUS P 800 CG

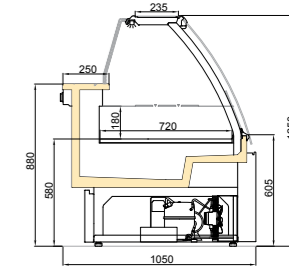

SPINOSAURUS P 700 CG

### Available Modules / Kullanılabilir Modüller

Length/Uzunluk (mm)	937	1250	1875	2500
Side panel/ Yan kapak (mm)	40	40	40	40

Operating Temperatures / Çalışma Sıcaklıkları	Ambient Conditions Ortam Koşulları
M1 (-1/+5°C) - M2 (-1/+7°C)	25°C / 60% RH (EN ISO 23953-2)





# T-REX

Soğutmalı Depolu Servis Reyonu  
Refrigerated Serve Over Counter With Storage



Soğutmalı Depolu Servis Reyonu  
Refrigerated Serve Over Counter With Storage

# T-REX

OUR DESIGN

## TEKNİK DETAYLAR Technical Details

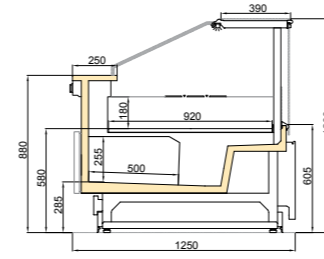

T-REX 900 FG

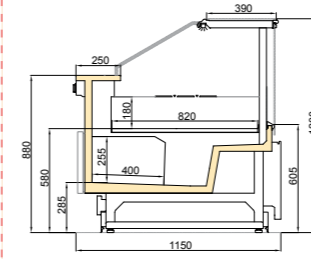

T-REX 800 FG

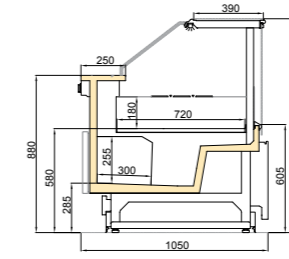

T-REX 700 FG

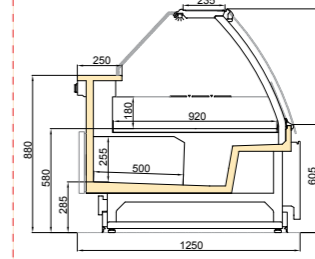

T-REX 900 CG

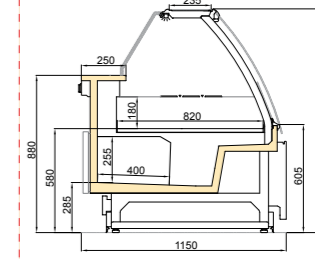

T-REX 800 CG

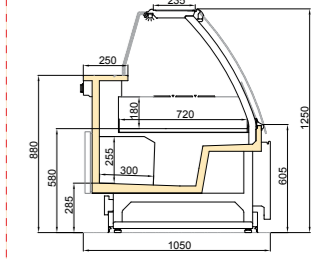

T-REX 700 CG

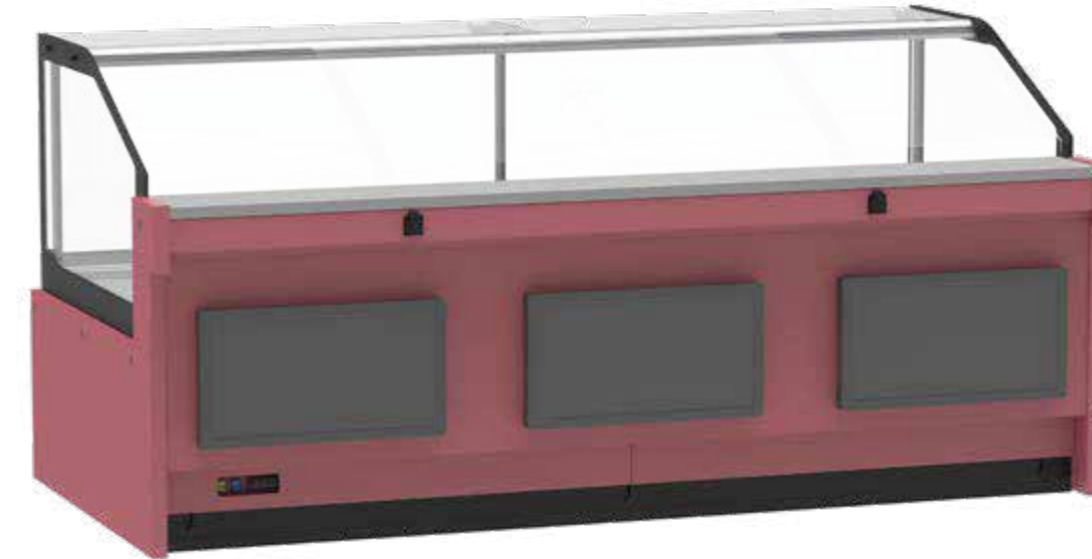

Available Modules / Kullanılabilir Modüller						
Length/Uzunluk (mm)	937	1250	1875	2500	3750	Gondola / Head
Side panel/ Yan kapak (mm)	40	40	40	40	40	40
Operating Temperatures / Çalışma Sıcaklıkları			Ambient Conditions / Ortam Koşulları			
M1 (-1/+5°C) - M2 (-1/+7°C)			25°C / 60% RH (EN ISO 23953-2)			





# T-REX P

İçten Motorlu Soğutmalı Depolu Servis Reyonu  
Plug-in Refrigerated Serve Over Counter With Storage

İçten Motorlu Soğutmalı Depolu Servis Reyonu  
Plug-in Refrigerated Serve Over Counter With Storage

OUR DESIGN

## TEKNİK DETAYLAR Technical Details

# T-REX P

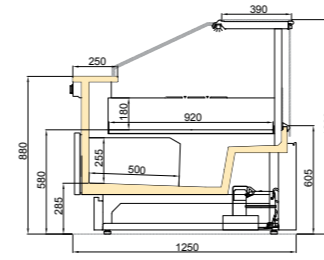
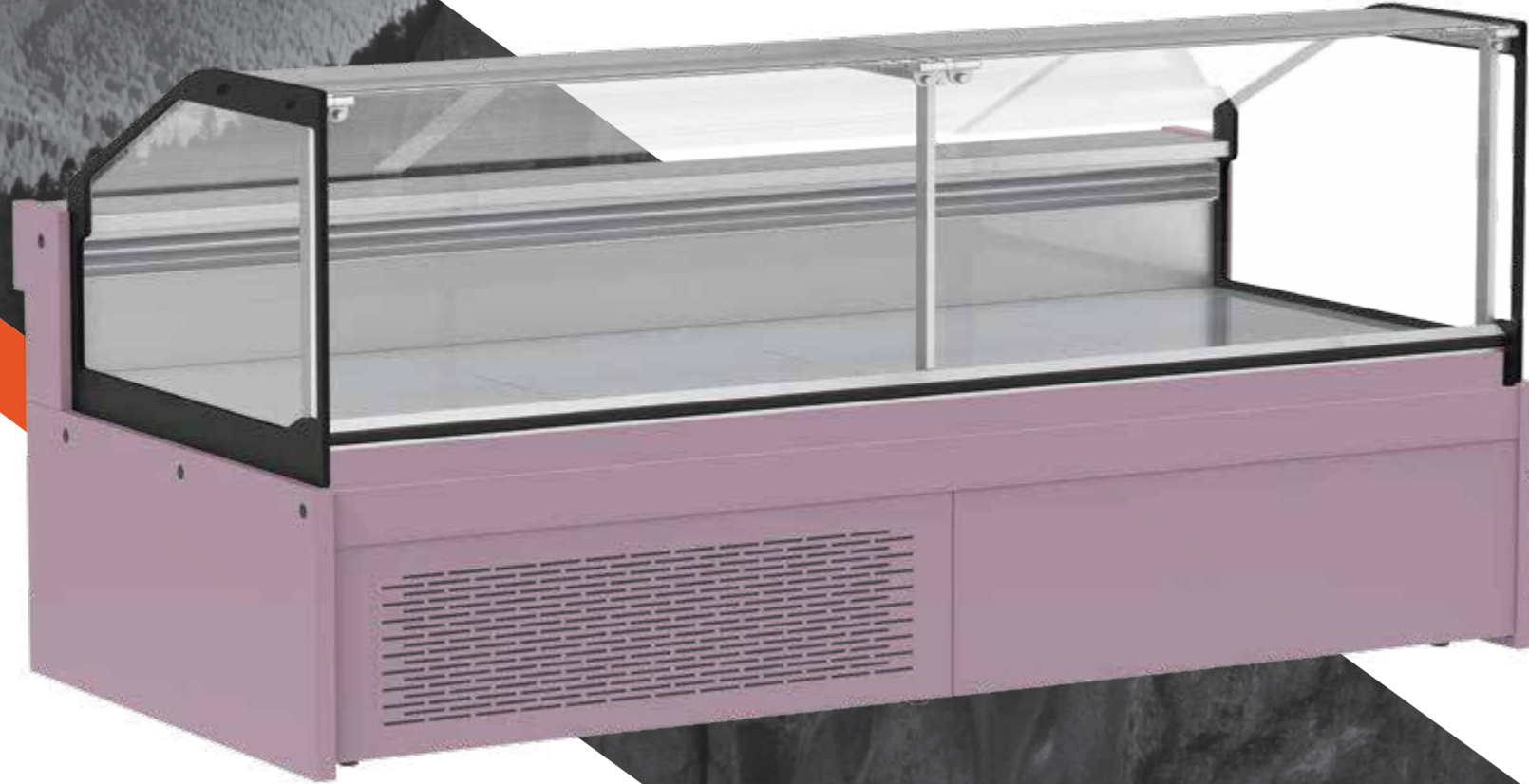

T-REX P 900 FG

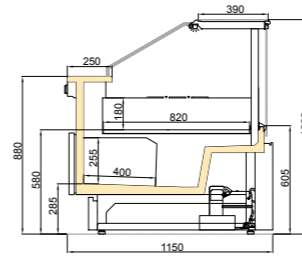

T-REX P 800 FG

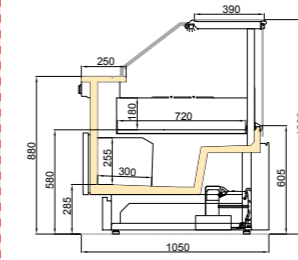

T-REX P 700 FG

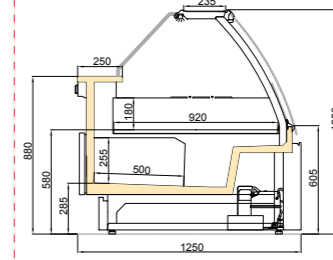

T-REX P 900 CG

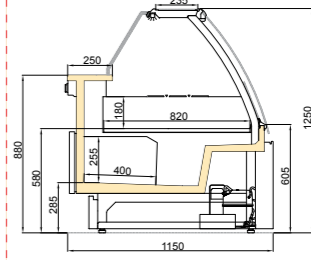

T-REX P 800 CG

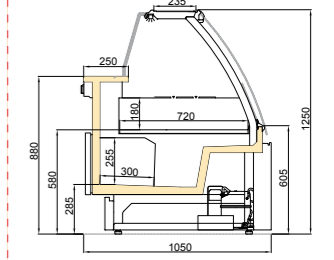

T-REX P 700 CG



### Available Modules / Kullanılabilir Modüller

Length/Uzunluk (mm)	937	1250	1875	2500
Side panel/ Yan kapak (mm)	40	40	40	40

Operating Temperatures / Çalışma Sıcaklıkları	Ambient Conditions Ortam Koşulları
M1 (-1/+5°C) - M2 (-1/+7°C)	25°C / 60% RH (EN ISO 23953-2)





# ARENUS

Çift Katlı Servis Reyonu  
Double Decker Service Rayon

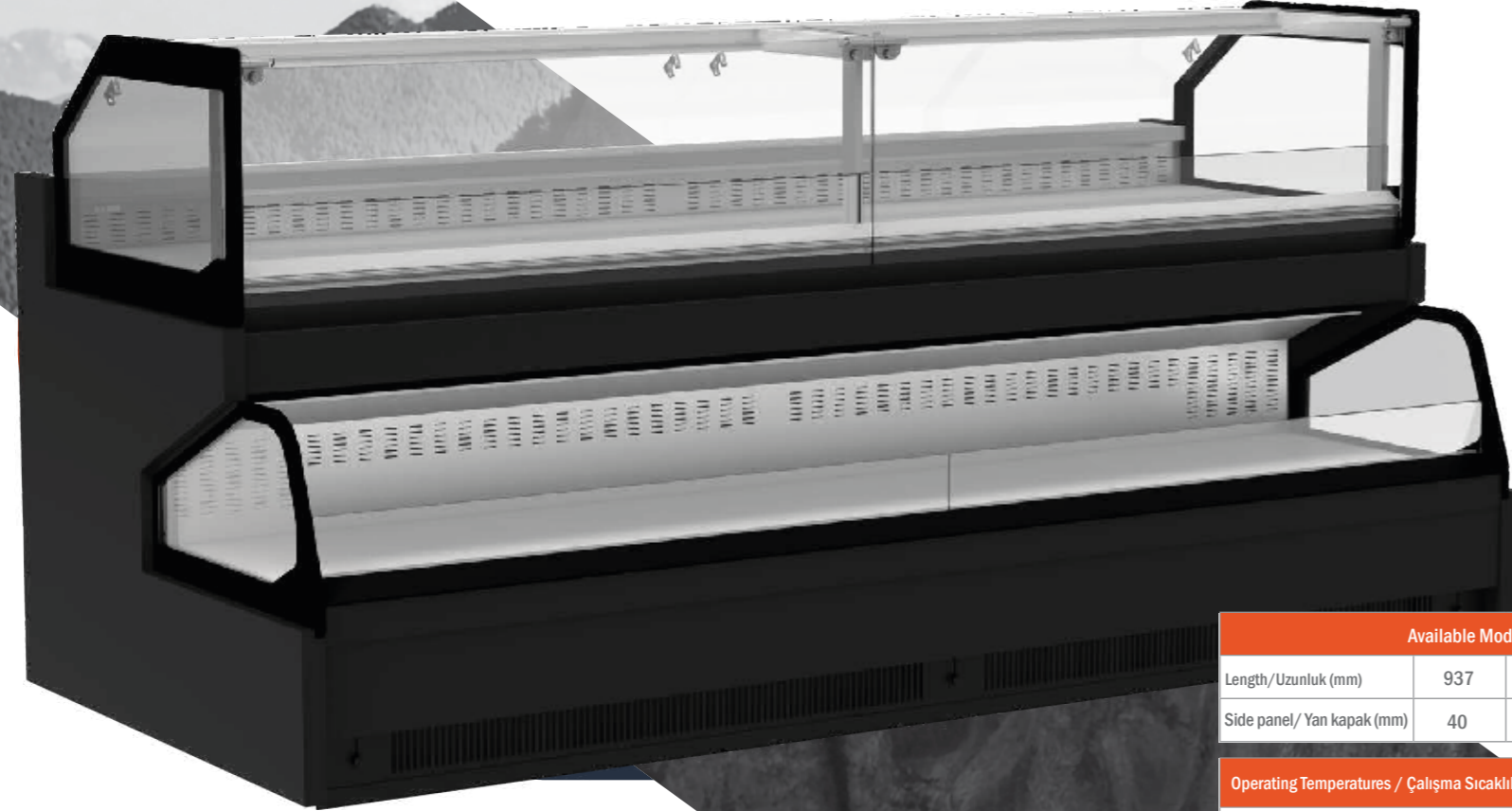

## TEKNİK DETAYLAR Technical Details

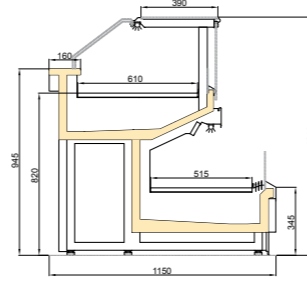

ARENUS BOX

Available Modules / Kullanılabilir Modüller					
Length/Uzunluk (mm)	937	1250	1875	2500	3750
Side panel/ Yan kapak (mm)	40	40	40	40	40
Operating Temperatures / Çalışma Sıcaklıkları			Ambient Conditions / Ortam Koşulları		
M1 (-1/+5°C) - M2 (-1/+7°C)			25°C / 60% RH (EN ISO 23953-2)		



İçten Motorlu Promosyon Reyonu  
Promotion Plug-in

# SALTOPUS FG



## TEKNİK DETAYLAR Technical Details

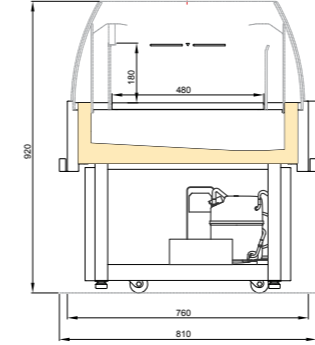

SALTOPUS FG 800 CG

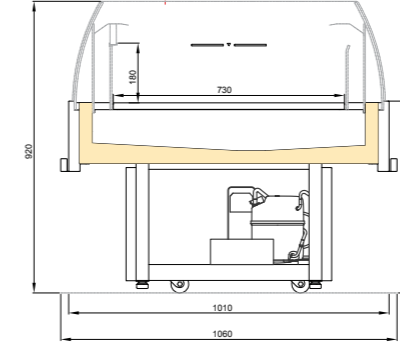

SALTOPUS FG 1000 CG

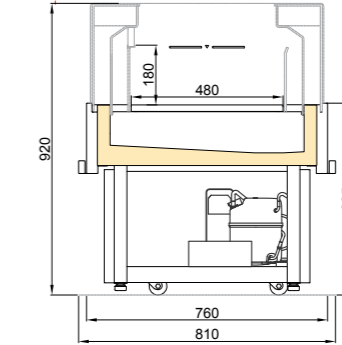

SALTOPUS FG 800 FG

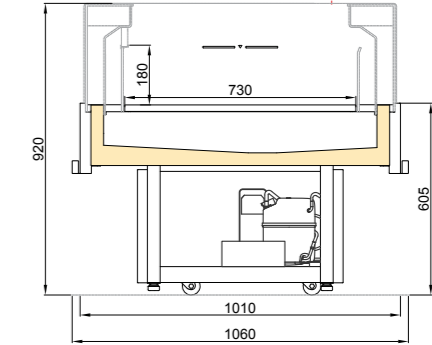

SALTOPUS FG 1000 FG



Available Modules / Kullanılabilir Modüller					
Length/Uzunluk (mm)	937	1250	1875	2500	3750
Side panel/ Yan kapak (mm)	40	40	40	40	40
Operating Temperatures / Çalışma Sıcaklıkları			Ambient Conditions / Ortam Koşulları		
M1 (-1/+5°C) - M2 (-1/+7°C)			25°C / 60% RH (EN ISO 23953-2)		







 OUR DESIGN





OUR DESIGN

[www.ourdesignarc.com](http://www.ourdesignarc.com)  
[info@ourdesignarc.com](mailto:info@ourdesignarc.com)